

Technická dokumentácia

Technical drawings

KINETICS GP

3AL 80-132 B14B

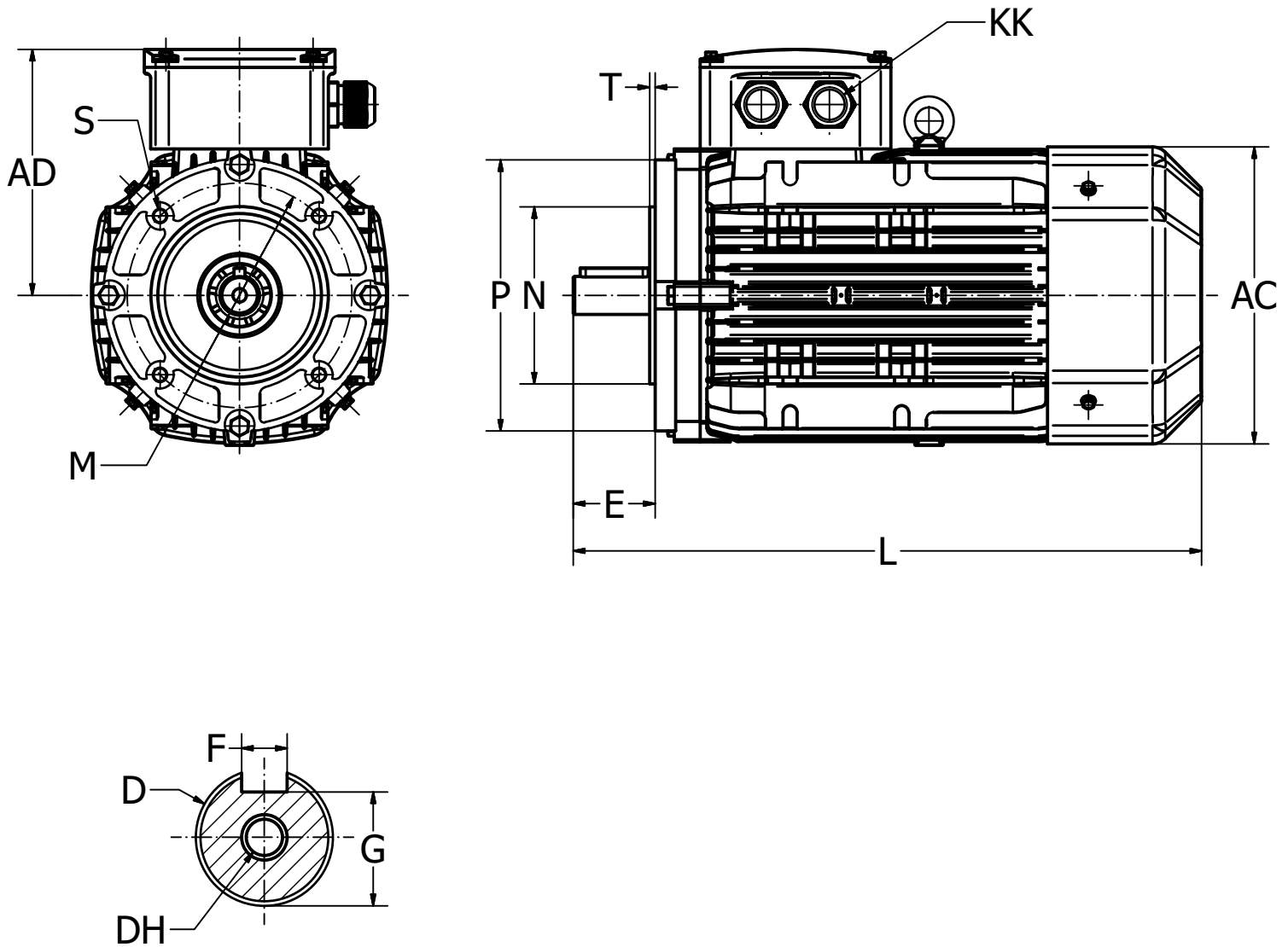

Montovacie rozmery

3AL 80-132 B14B

Všeobecné rozmery

Mounting dimensions

Overall dimensions

Velkost rámu Frame size	Póly	A	A/2	B	C	D	E	F	G	H	K	M	N	P	S	T	Dieri príruby Flange holes	AB	AC	AD	HD	L	DH*
80M	2 4 6 8	125	62.5	100	50	19	40	6	15.5	80	10	165	130	200	12	3.5	4	165	156	138	218	295	M6X16
90S	2 4 6 8	140	70	100	56	24	50	8	20	90	10	165	130	200	12	3.5	4	180	177	152	242	353	M8x19
90L	2 4 6 8	140	70	125	56	24	50	8	20	90	10	165	130	200	12	3.5	4	180	177	152	242	373	M8x19
100L	2 4 6 8	160	80	140	63	28	60	8	24	100	12	215	180	250	15	4	4	205	197	160	260	433	M10X22
112M	2 4 6 8	190	95	140	70	28	60	8	24	112	12	215	180	250	15	4	4	230	218	181	293	461	M10X22
132S	2 4 6 8	216	108	140	89	38	80	10	33	132	12	265	230	300	15	4	4	260	258	212	344	499	M12x28
132M	2 4 6 8	216	108	178	89	38	80	10	33	132	12	265	230	300	15	4	4	260	258	212	344	521	M10X28